

# **marantz®**

**Model PM7001 User Guide**

---

Integrated Amplifier

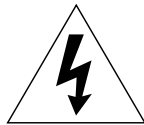
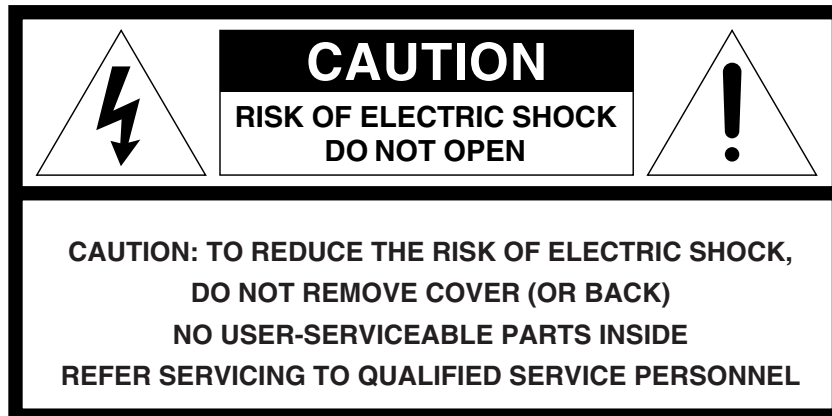

The lightning flash with arrowhead symbol within an equilateral triangle is intended to alert the user to the presence of uninsulated “dangerous voltage” within the product’s enclosure that may be of sufficient magnitude to constitute a risk of electric shock to persons.



The exclamation point within an equilateral triangle is intended to alert the user to the presence of important operating and maintenance (servicing) instructions in the literature accompanying the product.

## WARNING

**TO REDUCE THE RISK OF FIRE OR ELECTRIC SHOCK,  
DO NOT EXPOSE THIS PRODUCT TO RAIN OR MOISTURE.**

---

**CAUTION: TO PREVENT ELECTRIC SHOCK, MATCH WIDE  
BLADE OF PLUG TO WIDE SLOT, FULLY INSERT.**

**ATTENTION: POUR ÉVITER LES CHOC ÉLECTRIQUES,  
INTRODUIRE LA LAME LA PLUS LARGE DE LA FICHE DANS  
LA BORNE CORRESPONDANTE DE LA PRISE ET POUSSER  
JUSQU’AU FOND.**

---

# IMPORTANT SAFETY INSTRUCTIONS

## READ BEFORE OPERATING EQUIPMENT

This product was designed and manufactured to meet strict quality and safety standards. There are, however, some installation and operation precautions which you should be particularly aware of.

1. Read these instructions.
2. Keep these instructions.
3. Heed all warnings.
4. Follow all instructions.
5. Do not use this apparatus near water.
6. Clean only with dry cloth.
7. Do not block any ventilation openings. Install in accordance with the manufacture's instructions.
8. Do not install near any heat sources such as radiators, heat registers, stoves, or other apparatus (including amplifiers) that produce heat.
9. Do not defeat the safety purpose of the polarized or grounding-type plug. A polarized plug has two blades with one wider than the other. A grounding type plug has two blades and a third grounding prong. The wide blade or the third prong are provided for your safety. If the provided plug does not fit into your outlet, consult an electrician for replacement of the obsolete outlet.
10. Protect the power cord from being walked on or pinched particularly at plugs, convenience receptacles, and the point where they exit from the apparatus.
11. Only use attachments/accessories specified by the manufacturer.
12. Use only with the cart, stand, tripod, bracket, or table specified by the manufacturer, or sold with the apparatus. When a cart is used, use caution when moving the cart/apparatus combination to avoid injury from tip-over.



13. Unplug this apparatus during lightning storms or when unused for long periods of time.
14. Refer all servicing to qualified service personnel. Servicing is required when the apparatus has been damaged in any way, such as power-supply cord or plug is damaged, liquid has been spilled or objects have fallen into the apparatus, the apparatus has been exposed to rain or moisture, does not operate normally, or has been dropped.

### Additional Safety Information!

- This product should not be placed in a built-in installation such as a bookcase or rack unless proper ventilation is provided or the manufacturer's instructions have been adhered to.
- Apparatus shall not be exposed to dripping or splashing and that no objects filled with liquids, such as vases, shall be placed on the apparatus.
- When the switch is in the OFF position, the apparatus isn't completely switched-off from the MAINS.

# CONTENTS

BEFORE USE .....	1
FEATURES .....	2
BEFORE MAKING CONNECTIONS .....	3
WIRING SPEAKER CABLE .....	3
BI-WIRING CONNECTION .....	3
CONNECTIONS .....	4
NAMES AND FUNCTIONS OF PARTS .....	6
FRONT PANEL .....	6
REAR PANEL .....	7
RC4001PM REMOTE CONTROLLER .....	8
BASIC OPERATION .....	11
PLAYBACK .....	11
RECORDING .....	11
HOW TO USE AND SET FEATURES .....	12
MAIN IN JACKS .....	12
REMOTE CONTROL JACKS .....	13
TROUBLESHOOTING .....	14
OTHERS .....	15
SPECIFICATIONS & DIMENSIONAL DRAWINGS .....	15

# BEFORE USE

This section must be read before any connection is made to the mains supply.

## ■ EQUIPMENT MAINS WORKING SETTING

Your Marantz has been prepared to comply with the household power and safety requirements that exist in your area.  
PM7001 can be powered by 120V AC only.

## ■ COPYRIGHT

Recording and playback of any material may require consent. For further information refer to the following:

- Copyright Act 1956
- Dramatic and Musical Performers Act 1958
- Performers Protection Acts 1963 and 1972
- Any subsequent statutory enactments and orders

## ■ Do Not Locate in the Following Places

To ensure long-lasting use, do not locate the PM7001 where:

- Exposed to direct sunlight.
- Near to sources of heat such as heaters.
- Highly humid or poorly ventilated.
- Dusty.
- Subjected to mechanical vibrations.
- On wobbly, inclined or otherwise unstable surfaces
- Radiated heat is blocked such as in cramped audio racks.

To ensure proper heat radiation, ensure the below clearance from walls and other equipment.

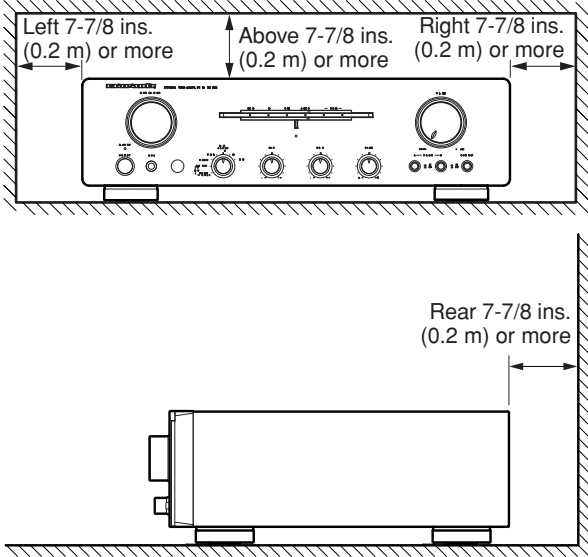

## ■ Keep Objects Off

Keep objects off the PM7001. Blocking the vent can result in accident and damage.

## ■ Do Not Touch Hot Spots During and Immediately After Use

During and immediately after use, the PM7001 is hot in areas other than the controls and rear panel connection jacks. Do not touch hot spots and especially the top panel. Contact with hot areas can cause burns.

## ■ Battery Handling

Improper use of dry cell batteries can result in electrolyte leaks, rupture and corrosion. Read the following precautions before use.

- If not planning to use the remote controller for an extended period of 1 month or more, remove the batteries.
- Do not mix old batteries with new batteries.
- Load batteries in the proper direction indicated on the remote controller.
- Do not mix batteries of differing type. Even batteries of the same shape and size can have differing voltages.
- If batteries leak, wipe the case clean of any adhering electrolyte and replace the old batteries with new batteries.

## ■ Accessories Check

Before use, check the below accessories were included in the package.

- AC power cable

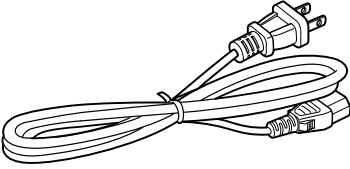

The power cable included in the package can be used with the PM7001 only. It cannot be used with other equipment.

- RC4001PM remote controller
- AA-size batteries x 2

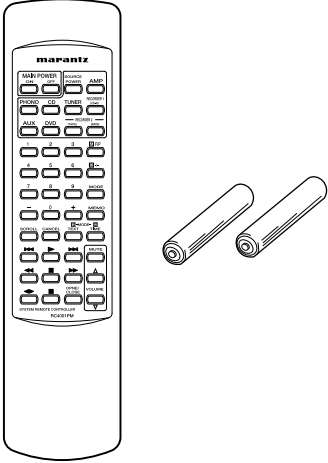

- Registration Card
- User Guide (This manual)

## FEATURES

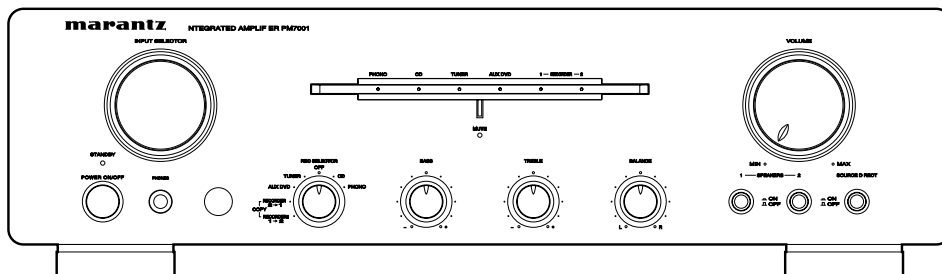

The PM7001 is an integrated amplifier developed on the design concepts of Marantz's PM-11S1 high-end model amplifier.

- **CD Direct Buffer Amplifier**

The PM7001 incorporates a specialized input buffer amplifier nearby the CD input jack. This buffer amplifier faithfully transmits the CD input jack signal by preventing interference from between the left and right channels, and from the effects of other circuits. A discrete configuration high-speed buffer amplifier which is built on the HDAM<sup>®</sup>SA technology is incorporated into the buffer amplifier circuit.

- **CD Direct Selector**

The output of CD direct buffer amplifier has a specialized relay switch, which directly transmits the input signal by the shortest path to the pre-amplifier.

- **Improved Momentary-Current Supply Capability**

It is known that sound quality differs between amplifiers that use the same spec, and Marantz believes that this is caused by differences in speaker drive capability. The PM7001 main-amplifier has the capability to momentarily pass 25 amperes or more of current, providing high-powered drive to the speakers.

- **Short Power Line Layout**

In order to improve the momentary-current supply capability, a new layout which places priority on making the large current line connections as short as possible was adopted.

In this layout the power supply circuit, main-amplifier output stage, and heatsink are unified, and the large current line is arranged to be as short as possible while still achieving symmetry on the left and right sides.

- **Current Feedback Amplifier**

Both pre-amplifier and main-amplifier incorporate a high-speed current feedback amplifier circuit, which faithfully amplify signals from the CD player. Moreover, the high-speed current feedback amplifier reproduces a natural sound field space.

# BEFORE MAKING CONNECTIONS

## WIRING SPEAKER CABLE

- Be careful not to short circuit in wiring speaker cables.
- Peel off the coating of speaker cable as shown below.

Approx.  
7/16 ins. (10 mm)

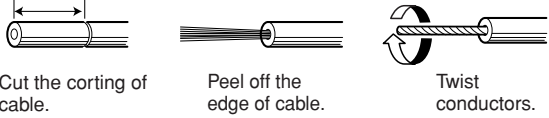

Cut the coating of cable.

Peel off the edge of cable.

Twist conductors.

- Wiring with speaker cable.

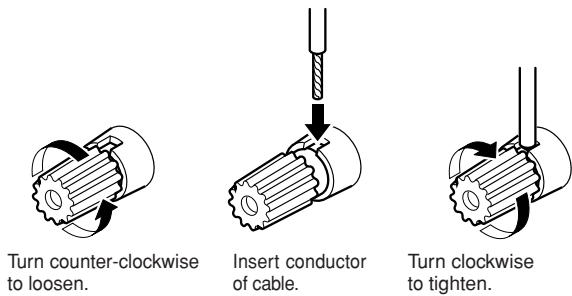

Turn counter-clockwise to loosen.

Insert conductor of cable.

Turn clockwise to tighten.

Your speaker system must satisfy the below conditions. If it does not, the PM7001's protective circuit will activate, whereby preventing proper playback. In some cases, the amplifier and speakers may be damaged.

- If using 1 set of speakers, total speaker impedance must be 4Ω or more.
- If using 2 sets of speakers, total speaker impedance must be 8Ω or more.

Here following is explained BI-WIRING connection that improve sound quality. The speakers in this explanation have low and mid/high input jacks that support a BI-WIRING connection. To determine whether or not your speakers support a BI-WIRING connection, check in the instruction manual that came with your speakers or contact the manufacturer.

## BI-WIRING CONNECTION

A bi-wiring connection separately connects the low and mid/high jacks of the speaker to the amplifier using separate speaker cables. Because separate cables are used for low and mid/high sounds, the kick back current in the low speaker causes little interference with the mid/high speaker. The PM7001 and speakers of Connection Example 1 (pg. 5) use a bi-wiring connection, therefore also refer to that page for help.

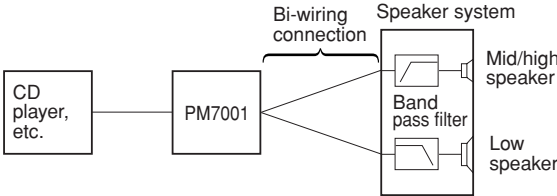

# CONNECTIONS

## Connection Example : Basic Connection for Stereo Playback

Refer also to the instruction manuals of components to connect equipment correctly.

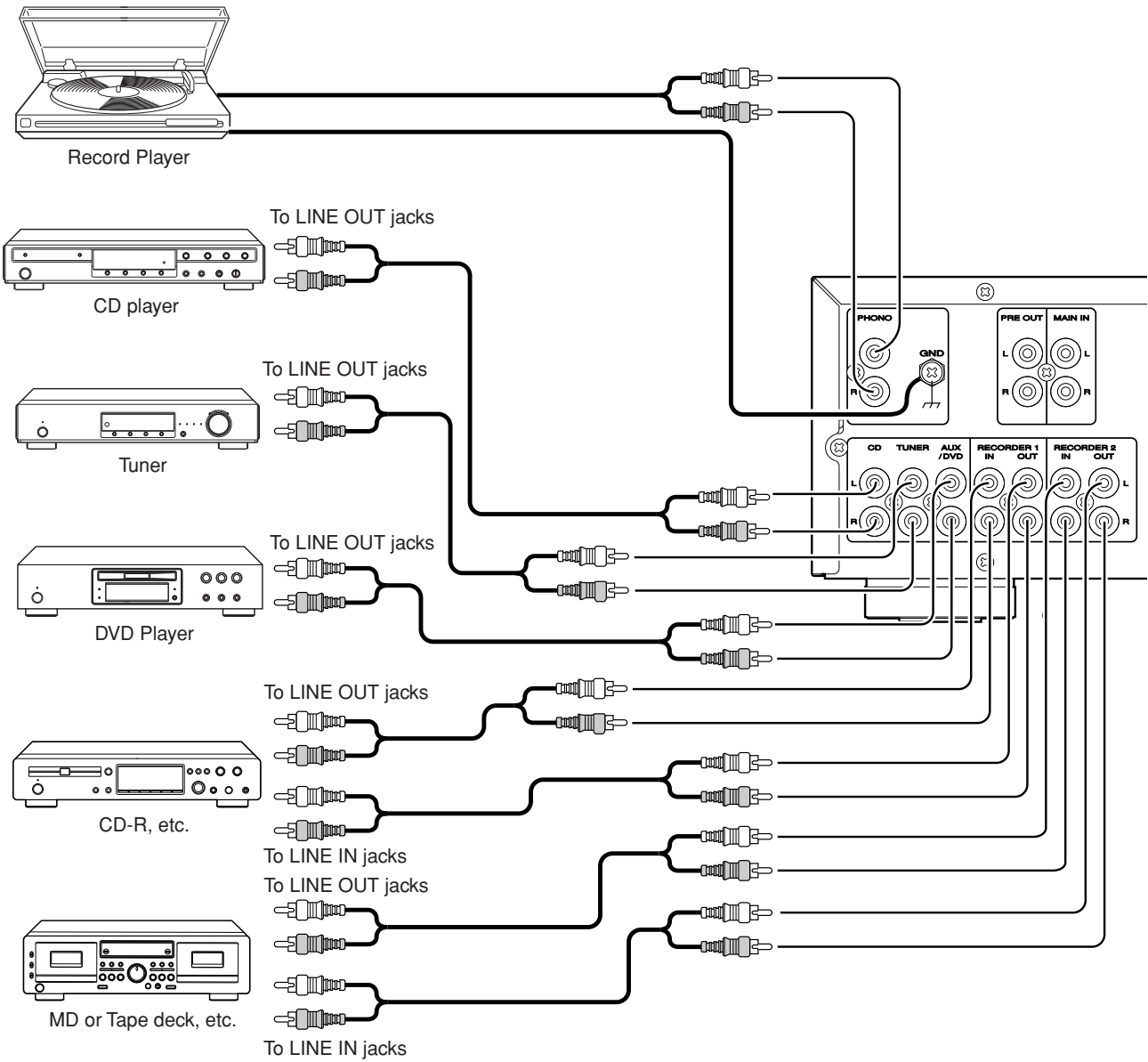



## CONNECTIONS

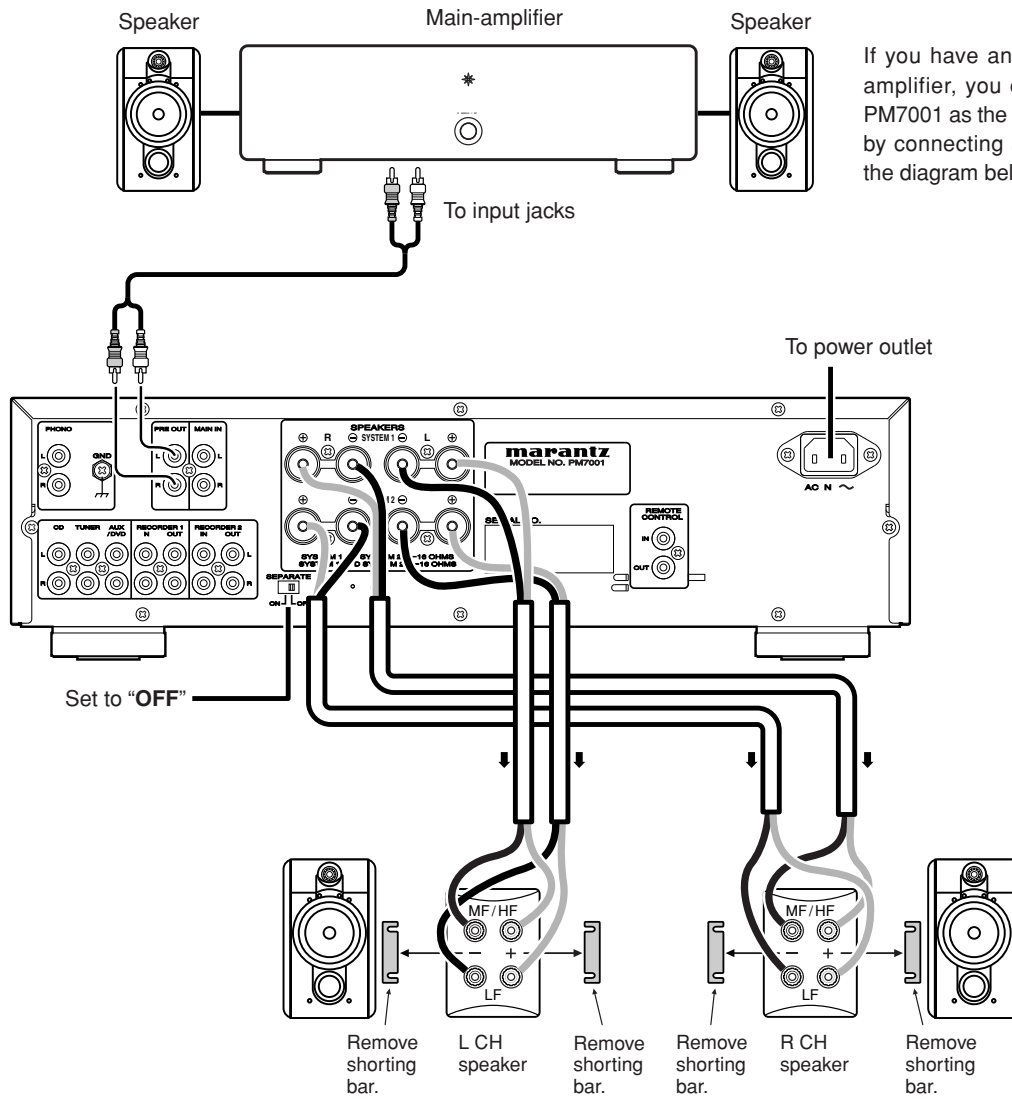

If you have another main-amplifier, you can use the PM7001 as the pre-amplifier by connecting as shown in the diagram below.

- Use a bi-wiring connection (pg. 3) for speakers.
- Set the **SPEAKERS** button 1 and button 2 on the front panel in the ON position.

# NAMES AND FUNCTIONS OF PARTS

## FRONT PANEL

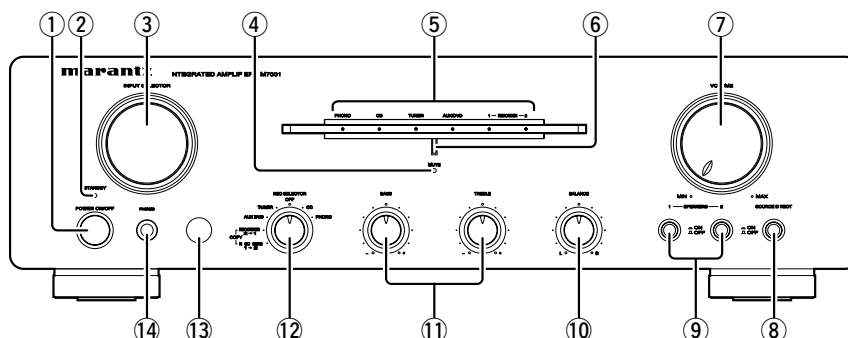

### ① POWER ON/OFF button

Pressing this button once turns power to the amplifier ON, and pressing it again turns power to the amplifier OFF. When the button is in the ON position, power can be switched ON/OFF using the supplied remote controller. If the power is switched OFF using the remote controller, the amplifier engages in standby mode. When in this mode, you cannot switch the power ON by pressing the **POWER ON/OFF** button ①. The amplifier remains in standby mode even if this button is pressed. To switch the power ON, either turn the **INPUT SELECTOR** knob ③ or press the **MAIN POWER ON** button ① on the remote controller.

### ② STANDBY indicator

This indicator is lit red when the amplifier is in standby mode. When in standby mode, you can switch the power ON by using the **MAIN POWER ON** button ① on the remote controller. If the amplifier's protective circuit activates, this indicator flashes and the amplifier's power automatically shuts off.

### ③ INPUT SELECTOR knob

This knob selects the input source for playback. The selected input source is displayed on the function indicator. The amplifier memorize the selected input source when the power is turned OFF, and then re-selects the same input source when the power is turned ON again.

### ④ MUTE indicator

When the **MUTE** button ③ on the remote controller is pressed, the MUTE function is activated and the volume is lowered. Pressing the **MUTE** button ③ again releases the MUTE function. Moreover, the MUTE function can also be released by pressing the **VOLUME ▲/▼** button ③ on the remote controller. If the amplifier's protective circuit activates, this indicator flashes for approx. 15 seconds and the MUTE function activates. While this indicator is flashing, the **VOLUME** knob ⑦ automatically turns and the volume decreases.

### ⑤ Function indicator

This indicator displays the input source currently selected by the **INPUT SELECTOR** knob ③.

### ⑥ Power indicator

This indicator is lit a blue color while power to the PM7001 is ON.

### ⑦ VOLUME knob

Turning this knob clockwise increases the volume, while turning it counterclockwise decreases the volume. The volume can also be adjusted using the remote controller. If the amplifier's protective circuit activates, the **VOLUME** knob ⑦ automatically turns for approx. 15 seconds and the volume decreases.

### ⑧ SOURCE DIRECT button

When this button is pressed in, the audio signal is transmitted bypassing the balance and tone control circuits, allowing you to enjoy a higher level of sound quality.

### ⑨ SPEAKERS 1/2 buttons

These buttons turn the speaker output to the speakers connected to the **SPEAKERS SYSTEM 1** and **2** terminals ⑨ on the rear panel **ON** and **OFF**. When listening with headphones, turn the speaker output **OFF**.

### ⑩ BALANCE knob

This knob is used to adjust the sound level from one of either the **L** (left) or **R** (right) channels. If the **BALANCE** knob ⑩ is turned all the way round to one side, sound is not output from the opposite side.

Please note that this knob does not function when the **SOURCE DIRECT** button ⑧ is in the **ON** position.

### ⑪ Tone Control knobs (BASS/TREBLE)

These knobs are used to adjust the BASS and TREBLE sound level. Turning the knobs clockwise increases the sound level, and turning them counterclockwise decreases the sound level. Please note that these knobs do not function when the **SOURCE DIRECT** button ⑧ is in the **ON** position.

### ⑫ REC SELECTOR knob

This knob switches the input sources for recording. Moreover, you can connect a tape deck, CD-R player, and other such device to the **RECORDER 1** and **2** terminals ⑬ to make copies. We recommend the knob be set to the **OFF** position when not recording to obtain optimal sound quality. (See page 11.)

## NAMES AND FUNCTIONS OF PARTS

### 13 Infrared Receptor Window

This is the receptor of control signals sent from the **RC4001PM** remote controller. Point the remote controller towards this window to properly transmit signals.

### 14 PHONES jack

This jack is for connecting headphones with a standard stereo plug. To listen with headphones, turn the speaker output OFF by setting the **SPEAKERS 1** and **2** buttons 9 in the **OFF** position.

## REAR PANEL

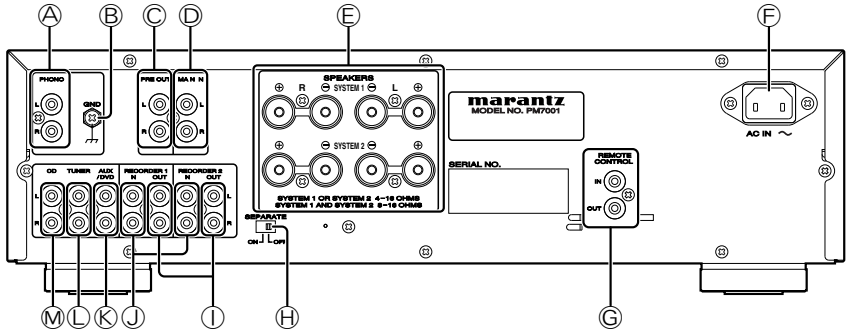

### A PHONO Input jacks

These jacks are for connecting to an analog record player. MM cartridges can be used.

### B PHONO GND terminal

Connect the grounding wire from an analog record player.

### C PRE OUT jacks

These jacks are for connecting to the input jacks of another main-amplifier or active subwoofer.

### D MAIN IN jacks

These jacks are for connecting to the output terminals of another pre-amplifier when using the PM7001 as the main-amplifier. In this case, set the **SEPARATE** switch H to the **ON** position.

### E SPEAKERS SYSTEM 1, 2 output terminals

You can connect 2 speaker systems, **SPEAKERS 1** and **SPEAKERS 2** E. Speaker output can be turned ON/OFF from the **SPEAKERS 1** and **2** buttons 9 on the front panel.

### F AC IN socket

Connect the supplied AC power cable to this socket and a power outlet.

### G REMOTE CONTROL jacks

These jacks are for connecting to other Marantz components such as a CD player or DVD player that has a remote control connector (D.BUS jack). You can use the remote controller supplied with the PM7001 to control the system. For more details, see page 13.

### H SEPARATE switch

This switch is used for selecting the pre-amplifier and main-amplifier connection modes.

**OFF:** Select this position when the amplifier is used as a normal integrated amplifier. (Standard factory setting)

**ON:** The pre-amplifier and main-amplifier are separated. The PM7001 can be used as a main-amplifier when input is connected to the **MAIN IN** jacks D.

### I RECORDER 1/RECORDER 2 output jacks

These jacks are for connecting to the recording input jacks of a CD-R recorder, MD deck, tape deck, etc. Output signals can be selected using the **REC SELECTOR** knob 12 on the front panel.

### J RECORDER 1/RECORDER 2 input jacks

These jacks are for connecting to the output jacks of a CD-R player, MD deck, tape deck, etc.

### K AUX/DVD input jacks

These jacks are for connecting to the output jacks of a DVD player or other LINE component.

### L TUNER input jacks

These jacks are for connecting to the output jacks of a tuner or other LINE component.

### M CD input jacks

These jacks are for connecting to the output jacks of a CD player or similar component.

## NAMES AND FUNCTIONS OF PARTS

### RC4001PM REMOTE CONTROLLER

Using this remote controller, you can control the PM7001 and Marantz CD players, DVD players, tuners, tape decks etc. that have a remote control receptor. The operations possible by remote controller may differ with each component; therefore see the instruction manual that came with the component. (See page 13)

The RC4001PM remote controller buttons are laid out as shown below.

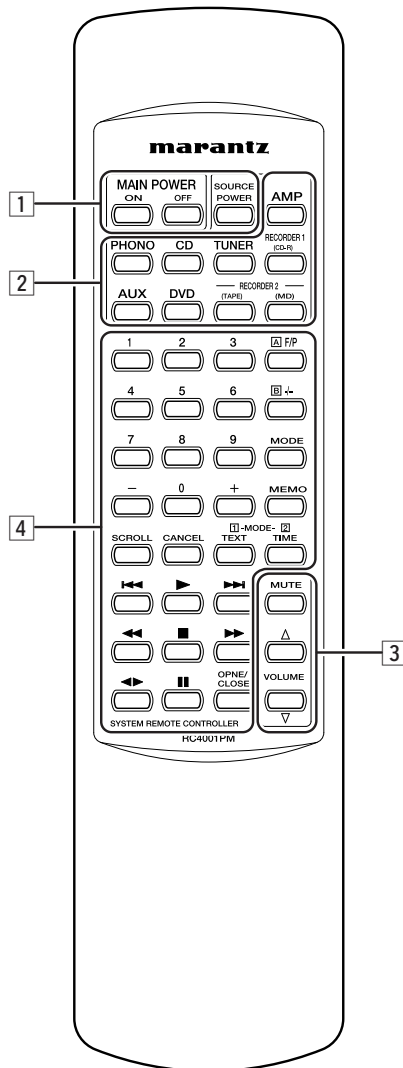

#### 1 Power ON/OFF buttons

- **MAIN POWER ON button**  
This button switches the power ON when the PM7001 is in **STANDBY** mode.
- **MAIN POWER OFF button**  
This button switches the PM7001 to **STANDBY** mode when the power is ON.
- **SOURCE POWER button**  
This button switches between power **ON** and **STANDBY** modes for Marantz products that have a standby function. By pressing this button after one of the buttons in the button group [2], you can switch the power between **ON** and **STANDBY** modes for the Marantz product that corresponds to that button.  
By pressing this button after the **AMP** button [2], you can switch the PM7001 between power **ON** and **STANDBY** modes.

#### 2 Input selector buttons

This group of buttons is used for selecting the input source.

#### Caution

In the PM7001, **AUX** and **DVD**, and **RECORDER 2's TAPE** and **MD** each share the same input jacks. The signal codes for controlling these Marantz products using the RC4001PM differ, therefore separate buttons have been built into the remote controller.

#### 3 VOLUME adjustment buttons



- **MUTE Button**  
This button activates the mute function. Pressing this button again releases the **MUTE** function.  
The **MUTE** function can also be released by pressing either the **VOLUME ▲** or **VOLUME ▼** buttons [3].
- **VOLUME ▲ Button**  
This button increases the volume level.
- **VOLUME ▼ Button**  
This button decreases the volume level.













#### 4 Component operating buttons

These buttons are for performing basic operations of a Marantz CD player, DVD player, etc. The function of each button changes to match the component selected as the input source using the input selector buttons [2].



## NAMES AND FUNCTIONS OF PARTS













### ■ CD

When the **CD** button  is pressed, the buttons in group  function as indicated in the table below. These buttons can only be used when a Marantz CD player is connected to the **CD** input jacks .



BUTTON NAME	FUNCTION
 F/P	None
 -/--	Disc Select
MODE	Auto Music Scan (AMS)
MEMO	Program
SCROLL	Scroll/Recall Program
CANCEL	Cancel
TEXT (MODE  )	Text
TIME (MODE  )	Time
1 - 9	1 - 9
0	0
-	Previous Track
+	Next Track
	Play
	Previous Track
	Next Track
	Fast Reverse
	Fast Forward
	Stop
	None
	Pause
OPEN/CLOSE	Open/Close













### ■ DVD

When the **DVD** button  is pressed, the buttons in group  function as indicated in the table below. These buttons can only be used when a Marantz DVD player is connected to the **AUX/DVD** input jacks .



BUTTON NAME	FUNCTION
 F/P	Disc Skip
 -/--	Disc Skip
MODE	None
MEMO	None
SCROLL	None
CANCEL	None
TEXT (MODE  )	Audio
TIME (MODE  )	OSD
1 - 9	1 - 9
0	0
-	Previous Chapter
+	Next Chapter
	Play
	Previous Chapter
	Next Chapter
	Scan -
	Scan +
	Stop
	None
	Pause
OPEN/CLOSE	Open/Close













### ■ TUNER

When the **TUNER** button  is pressed, the buttons in group  function as indicated in the table below. These buttons can only be used when a Marantz tuner is connected to the **TUNER** input jacks .

BUTTON NAME	FUNCTION
 F/P	Frequency Direct
 -/--	Preset 10
MODE	T-mode (Stereo/Mono)
MEMO	Memo
SCROLL	Display
CANCEL	Cancel
TEXT (MODE  )	Preset Scan
TIME (MODE  )	IF Band
1 - 9	Preset 1 - Preset 9, 1 - 9
0	0
-	Preset Down
+	Preset Up
	None
	None
	None
	Tuning Down
	Tuning Up
	None
	None
	None
OPEN/CLOSE	None

### ■ TAPE

When the **RECORDER 2 (TAPE)** button  is pressed, the buttons in group  function as indicated in the table below. These buttons can only be used when a Marantz tape deck is connected to the **RECORDER 2 (TAPE)** jacks .

BUTTON NAME	FUNCTION
 F/P	Deck A
 -/--	Deck B
MODE	None
MEMO	None
SCROLL	None
CANCEL	Counter Reset
TEXT (MODE  )	None
TIME (MODE  )	Time/Display
1 - 9	None
0	None
-	Back Skip
+	Forward Skip
	Play
	Back Skip
	Forward Skip
	Fast Rewind
	Fast Forward
	Stop
	Direction
	Pause
OPEN/CLOSE	Eject

## NAMES AND FUNCTIONS OF PARTS

### ■ For use of Remote controller

#### • Loading batteries

Before using the remote controller for the first time, load the batteries in the remote controller. The batteries provided are used to verify the operations of the remote controller only.

1. Remove the battery cover which is found on the back side of the remote controller.

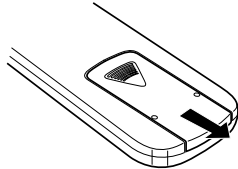

2. Load the two new size "AA" batteries inside the battery compartment while taking care to align their polarities correctly with the polarity markings (+ with + and - with -).

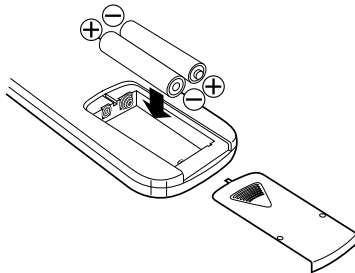

3. Push the cover on the back side in the direction of the arrow to close.

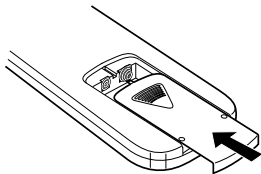

### ■ Operatable range of Remote controller

Operate the remote controller (RC4001PM) within a distance of approx. 5m from the infrared receptor window on the front of the PM7001.

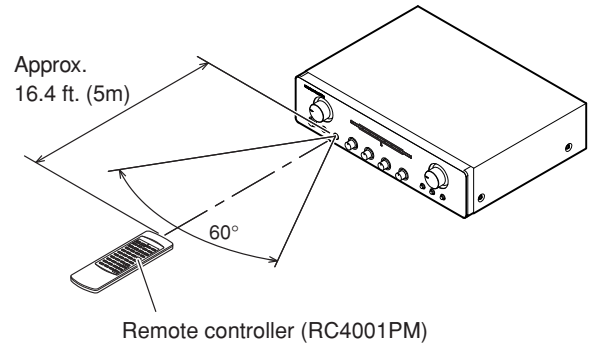

#### • Caution

- Do not allow direct sunlight, an inverter fluorescent light or other strong source of light to shine onto the player's infrared receptor window. Otherwise, the operation of the remote controller may be disabled.
- Bear in mind that operating the remote controller may cause other devices operated by infrared rays to be operated by mistake.
- The remote controller cannot be operated if the space between the controller and the player's infrared receptor window is obstructed.
- Do not place any objects on top of the remote controller. Doing so may cause one or more buttons to be held down which will cause the batteries to run down.

# BASIC OPERATION

## PLAYBACK

To explain how to play back input sources, representative examples are given with an CD player and analog record player. Before starting either procedure, check the component is correctly connected to the PM7001.

### Disc Playback on an CD Player

1. Press the power ON/OFF button of the CD player to activate power to it.
2. Press the **POWER ON/OFF** button ① to activate power to it. Approximately 8 seconds after power has been activated, the muting turns OFF and audio output is enabled.
3. Select the **CD** from the **INPUT SELECTOR** knob ③.
4. To use the speakers connected to the **SPEAKERS SYSTEM** terminals, press the **SPEAKERS** button 1 and 2 ⑨.
5. Load a disc into the CD player and press the play button to start playback.
6. Adjust the volume level from the **VOLUME** knob ⑦.
7. Adjust bass/treble as desired from the **BASS** and **TREBLE** knobs ⑪. Be sure to first set the **SOURCE DIRECT** button ⑧ in the **OFF** position.

### Disc Playback on an Analog Record Player

1. Press the **POWER ON/OFF** switch ① to activate power to it. Approximately 8 seconds after power has been activated, the muting turns OFF and audio output is enabled.
2. Select "PHONO" as the input source from the **INPUT SELECTOR** knob ③. To prevent unexpected accidents, it is recommended to set the volume level to **MIN.** by turning the **VOLUME** knob ⑦ until muting the volume level.
3. MM type cartridges can be connected. Use a step-up transformer when using an MC cartridge.
4. To use the speakers connected to the **SPEAKERS SYSTEM** terminals, press the **SPEAKERS** button 1 and 2 ⑨.
5. Set a record on the analog record player and play it.
6. Adjust the volume level from the **VOLUME** knob ⑦.
7. Adjust bass/treble as desired from the **BASS** and **TREBLE** knobs ⑪. Be sure to first set the **SOURCE DIRECT** button ⑧ in the **OFF** position.

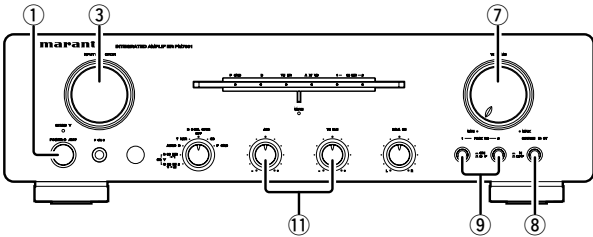

## RECORDING

This example explains how to record from an input source such as an CD player to a recording device such as a CD-R.

1. Press the power ON/OFF switch of the CD player and CD-R to activate power to both components.
2. Press the **POWER ON/OFF** switch ① to activate power to it. Approximately 8 seconds after power has been activated, the muting turns OFF and audio output is enabled.
3. Select the **CD** with the **REC SELECTOR** knob ⑫. If you want to listen to the recording source through the speakers, set the **INPUT SELECTOR** knob ③ to the **CD** position.
4. Load a playback disc into the CD player and a recording disc into the CD-R.
5. Start playback on the CD player. Then, start recording on the CD-R.

### About the REC SELECTOR

The **REC SELECTOR** knob ⑫ can be operated independently, irrespective of the input source selected using the **INPUT SELECTOR** knob ③.

- OFF:**  
Cannot record because no signal is output to the **RECORDER 1, 2** jacks.
- PHONO, CD, TUNER, AUX/DVD:**  
Selects the program source for recording.
- COPY RECORDER 1-2:**  
Select this to copy the **RECORDER 1** signal onto **RECORDER 2**.
- COPY RECORDER 2-1:**  
Select this to copy the **RECORDER 2** signal onto **RECORDER 1**.

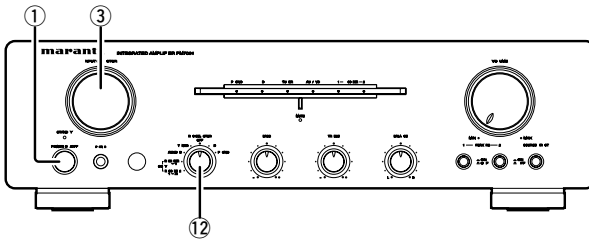

# HOW TO USE AND SET FEATURES

## MAIN IN JACKS

You can separate the pre-amplifier section and main-amplifier section by using the **SEPARATE** switch settings on the PM7001. If you have another pre-amplifier, you can use the PM7001 as the main-amplifier by connecting as shown in the diagram below.

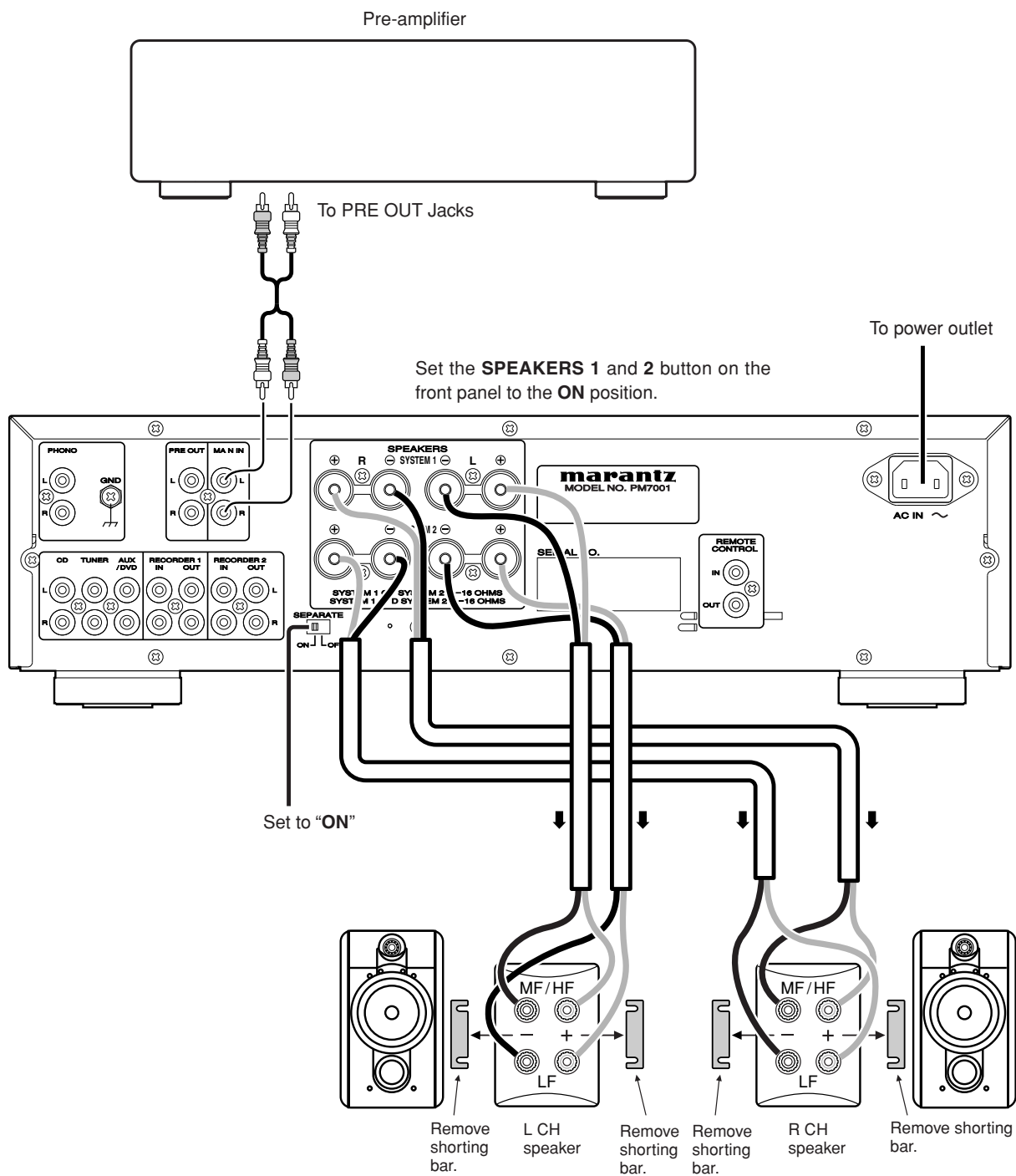

- Use a bi-wiring connection (pg. 3) for speakers.



## HOW TO USE AND SET FEATURES

### REMOTE CONTROL JACKS

The **REMOTE CONTROL** jacks are for connecting components that are capable of remote control (**D.BUS** jacks) such as a Marantz CD Player or DVD Player. This enables these other components to be operated with the remote controller included with the PM7001. The PM7001 comes with an RC4001PM system remote controller that can operate the basic features of Marantz CD Players and DVD Players. Here, a brief explanation of how to control the PM7001 and CD5001 using this remote controller is provided.

As shown in the illustration below, connect the **REMOTE CONTROL "IN"** jack of the CD5001 to the **REMOTE CONTROL "OUT"** jack of the PM7001, and set the CD5001 switch to "**EXTERNAL**".

Both the PM7001 and CD5001 can be operated by pointing the **RC4001PM remote controller** (pg. 8, 9, 10) at the receptor of the PM7001.

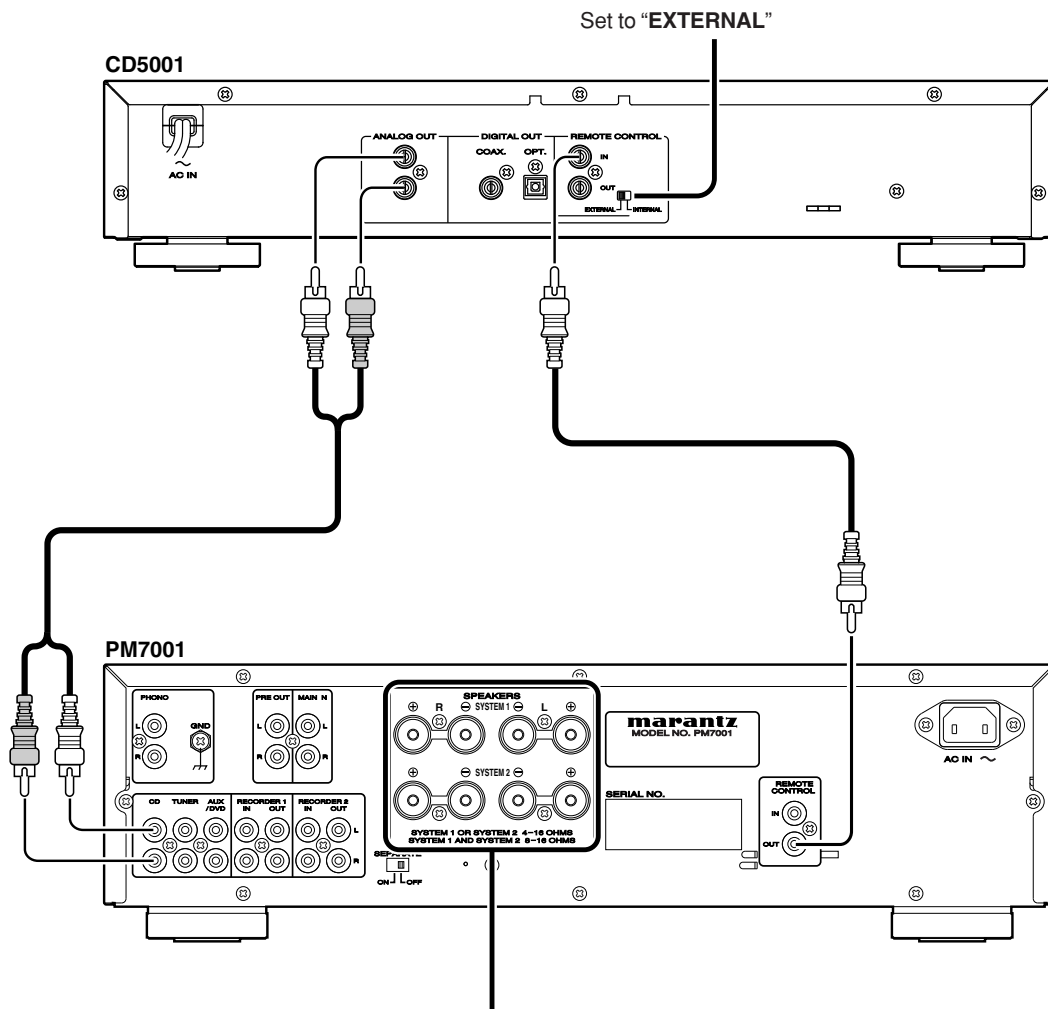

For details connecting the speakers, see page 5.

## TROUBLESHOOTING

### ■ Before considering it as a failure

In case of trouble with this component, first check the following before calling for service.

What seems to be a serious malfunction is often due to a simple operation mistake.

If the trouble is not fixed after making the following checks, contact the place of purchase, your nearest Marantz dealer, our customer service center, or our repair service center.

#### \* Power does not turn ON.

1. Is the power cable plugged securely into the power outlet?
2. Isn't the **STANDBY** indicator above the **POWER ON/OFF** button lit? Either turn the **INPUT SELECTOR** knob, or press the **MAIN POWER ON** button on the remote controller.
3. If the **STANDBY** indicator is flashing, the protective circuit has been activated. Switch the PM7001's **POWER ON/OFF** button to the **OFF** position, wait for more than a minute, and then turn the power back ON.

#### \* Nothing is heard from the speakers.

1. Aren't the **SPEAKER 1** and **2** buttons on the front panel in the **OFF** position?
2. Isn't the **MUTE** function activated?
3. Did you make a mistake selecting the input source using the **INPUT SELECTOR** knob on the front panel?
4. Are you using the component correctly?
5. Are connection cables and speaker cables securely connected.
6. Is the **SEPARATE** switch on the rear panel set correctly?
7. The volume may have been muted by the protective circuit activated. Try adjusting the volume level again.

#### \* Record player audio is not heard, or contains a lot of noise.

1. Are the **PHONO** plugs connected correctly?
2. Connect the grounding wire from the record player to the **PHONO GND** terminal.
3. Is the cartridge connected properly to the tone arm?
4. Sometimes plugging the record player's power cable into the power outlet with the polarity reversed can reduce noise.

### ■ About the Protective Circuit

The PM7001 is equipped with a protective circuit to protect the amplifier circuits and speaker system against damage.

If the protective circuit is activated, the sound is instantly muted.

In this case, either the **MUTE** indicator in the center of the panel flashes, or the **STANDBY** indicator above the **POWER ON/OFF** button flashes.

#### • At Power On

For about 8 seconds after the power is turned on, the protective circuit is activated muting the sound to give the amplifier circuits time to stabilize. Once the amplifier circuits stabilize, the protective circuit releases and audio is enabled.

#### • In the Event of Overcurrent

The protective circuit is activated if current exceeding a certain level is detected, which can happen if excessive signal flow is input to the amplifier or if the PM7001 is connected to a speaker system of less than 4Ω impedance. The protective circuit is also activated if a speaker cable shorts.

In these cases, the **MUTE** indicator in the center of the panel flashes, and the volume is automatically reduced. Approximately 15 seconds later the protective circuit is released, therefore the volume needs readjusting to continue normal use.

Moreover, if the overcurrent continues, the amplifier's power shuts OFF and the **STANDBY** indicator above the **POWER ON/OFF** button flashes.

#### • If excessive ultra-bass signals are input

The protective circuit is also activated if ultra-bass signals that exceed the base signal range settings are input. In this case, the **MUTE** indicator in the center of the panel flashes, and the volume is automatically reduced. Approximately 15 seconds later, the protective circuit is released, therefore the volume needs readjusting to continue normal use. If excessive ultra-bass signal input continues or if DC voltage is detected due to trouble with the amplifier, the power shuts OFF and the **STANDBY** indicator above the **POWER ON/OFF** button flashes.

#### • If the Main-amplifier Overheats

The protective circuit is activated if the temperature of the main-amplifier section rises above a certain level, which can happen if the amplifier is continually used with excessive signal flow being input into it. The protective circuit is also activated when the set operating temperature is exceeded, which can happen if the vents on top of the amplifier are covered, or if the amplifier is installed on a cramped audio rack. In these cases, the **MUTE** indicator in the center of the panel flashes, and the volume is automatically reduced. Approximately 15 seconds later, the protective circuit is released, therefore the volume needs readjusting to continue normal use.

If the temperature does not sufficiently lower within a certain amount of time after the protective circuit activation, the power shuts OFF and the **STANDBY** indicator above the **POWER ON/OFF** button flashes.

#### • In the Event of Amplifier Trouble

The protective circuit is activated and the power is automatically shut OFF if an abnormality is detected in the power circuit. The same happens if the main fuse inside the amplifier blows. In these cases, the **STANDBY** indicator above the **POWER ON/OFF** button flashes.

# OTHERS

The section describes the care and maintenance tasks that must be performed to optimize the operation of your Marantz component.

## ■ Cleaning of equipment external surfaces

The exterior finish of your unit will last indefinitely with proper care and cleaning. Never use scouring pads, steel wool, scouring powders or harsh chemical agents (e.g., lye solution), alcohol, thinner, benzene, insecticide or other volatile substances as these will mar the finish of the equipment. Likewise, never use cloths containing chemical substances. If the equipment gets dirty, wipe the external surfaces with a soft, lint-free cloth. If the equipment becomes heavily soiled:

- dilute some washing liquid in water, in a ratio of one part detergent to six parts water.
- dip a soft, lint free cloth in the solution and wring it out until it is damp.
- wipe the equipment with the damp cloth.
- dry the equipment by wiping it with a dry cloth.

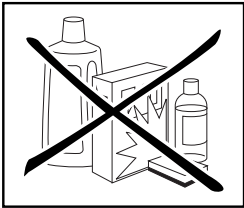

## ■ Repairs

Only the most competent and qualified service technicians should be allowed to service the factory-trained warranty station personnel have the knowledge and special facilities needed for repair and calibration of this precision equipment. After the warranty period has expired, repairs will be performed for a charge if the equipment can be returned to normal operation. In the event of difficulty, refer to your dealer or write directly to the nearest location to you that is listed on the Marantz Authorized Service Station list. If writing, please include the model and serial number of the equipment together with a full description of what you think is abnormal about the equipment's behaviour.

# SPECIFICATIONS & DIMENSIONAL DRAWINGS

- Power output (20 Hz – 20 kHz simultaneous drive of both channels)
  - ..... 70W x 2 (8Ω load)
  - ..... 100W x 2 (4Ω load)
- Total harmonic distortion (20Hz – 20kHz simultaneous drive of both channels, 8Ω load) ..... 0.02%
- Output band width (8Ω load, 0.05%) ..... 5Hz – 60kHz
- Frequency response (CD, 1W, 8Ω load) .... 5Hz – 100kHz ±3dB
- Damping factor (8Ω load, 20Hz – 20kHz) ..... 100
- Input sensitivity/Input impedance
  - PHONO (MM) ..... 2.5mV/47kΩ
  - CD, LINE, TUNER, AUX/DVD, RECORDER ..... 200mV/20kΩ
  - MAIN IN ..... 1.6V/20kΩ
- Output voltage/Output impedance
  - PRE OUT ..... 1.6 V/560Ω
- Maximum allowable PHONO input level (1kHz)
  - MM ..... 130mV
  - RIAA deviation (20Hz ~ 20kHz) ..... ±0.5dB
- S/N (IHF-A, 1W, 8Ω load)
  - PHONO (MM) ..... 85dB (5mV input)
  - CD, LINE, TUNER, AUX/DVD, RECORDER ..... 88dB (500mV input)
  - MAIN IN ..... 107dB
- Tone control
  - Bass (50Hz) ..... ±10dB
  - Treble (20kHz) ..... ±10dB
- Power requirement ..... AC 120V 60Hz
- Power consumption
  - (UL6500) ..... 250W
  - (4Ω, 100W x 2 output) ..... 470W
- Accessories
  - Remote controller ..... 1
  - AA batteries ..... 2
  - Detachable AC power cable ..... 1

- Maximum outer dimensions (Amplifier)
  - Width ..... 17-5/16 ins. (440 mm)
  - Height ..... 5 ins. (126.5 mm)
  - Depth ..... 14-3/8 ins. (364 mm)
  - Weight (Amplifier) ..... 23.1 lbs (10.5 kg)

Specifications subject to change without prior notice.

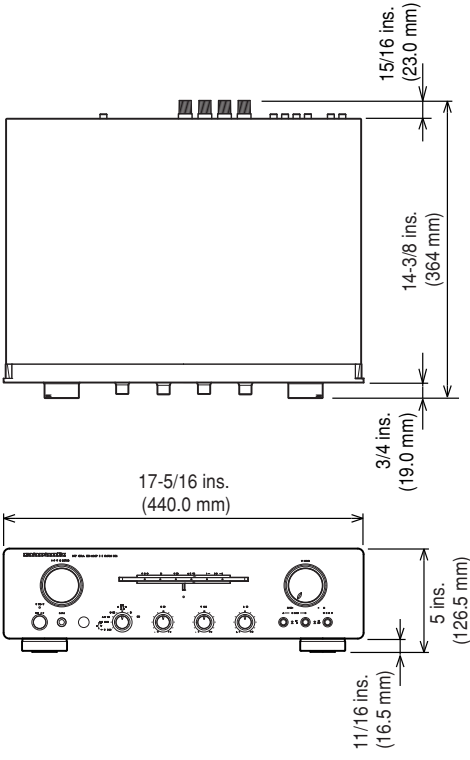

**www.marantz.com**

You can find your nearest authorized distributor or dealer on our website.

---

**U.S.A.** Marantz America, Inc. 1100 Maplewood Drive, Itasca, IL 60143, U.S.A.

**EUROPE** Marantz Europe B.V. P.O. Box 8744, 5605 LS Eindhoven, The Netherlands

---

**marantz**<sup>®</sup> is a registered trademark.